

# Rendering Moving Tactile Stroke on the Palm Using a Sparse 2D Array

Jaeyoung Park<sup>1</sup>(✉), Jaeha Kim<sup>1</sup>, Yonghwan Oh<sup>1</sup>, and Hong Z. Tan<sup>2</sup>

<sup>1</sup> Korea Institute of Science and Technology, Seoul, Korea  
{jypcubic, lithium81, oyh}@kist.re.kr

<sup>2</sup> Purdue University, West Lafayette, IN, USA  
hongtan@purdue.edu

**Abstract.** The present study presents a new rendering algorithm for a moving tactile stroke on the palm of the hand placed on a sparse 2D factor array. Our algorithm utilizes the relation between signal duration and signal onset asynchrony previously proposed for “tactile brush” [1], but extends it by applying 3-actuator phantom sensations and adjusting the sampling rate. We compare our proposed algorithm to the tactile brush algorithm for their similarity in target trajectories and uniformity of tactile stroke motions. The results show that the participants judge the tactile strokes with our algorithm to move significantly closer to target motions and with more uniform velocity than the “tactile brush.” The effect of our algorithm is more significant for experimental stimuli with longer travel time and length.

**Keywords:** Phantom sensation · Tactile brush · Tactile stroke

## 1 Introduction

One prominent direction in haptic interface design is to increase the quality and the quantity of tactile information through, for example, the use of multiple tactile actuators (tactors). Among various forms of multiple tactors, 2D tactile arrays have been studied to provide users with information such as temporal image, motional or directional cues. The tactile arrays have typically been used on a relatively large skin area including the back, waist or arm, but less commonly found on the glabrous area of hand where haptic sensitivity is high and the skin is easily accessible by devices such as desktop interfaces and wearable devices. In this regard, a 2D tactile array on the hand can be explored in various applications as a means to provide information to a user. We are especially interested in finding effective methods to deliver moving tactile sensations with controllable velocities and a clear start and end (e.g., [1, 2]).

So far, few studies have examined the robustness of rendering methodology for moving tactile strokes. An intuitive way to create a moving tactile stroke is to use a dense tactile factor array and to activate the tactors around a target trajectory sequentially. Borst and Asutay suggested a rendering method for a dense tactile array to create the sensation of moving tactors for arbitrary paths [3]. The drawback of this approach is that the hardware can be costly and heavy. Relatively sparse arrays of tactors were found to be effective in providing predefined set of cues [4, 5]. Sparse tactile arrays can

represent motion cues utilizing well-known illusory tactile phenomena such as sensory saltation [6] or phantom tactile sensation [7, 8]. Most of the previous studies can only create the illusion of motion between adjacent physical factors, limiting target motions to the line segments connecting the adjacent factors. Schneider et al. recently suggested a method to render a phantom factor on an arbitrary 2D position with three factors [9], but did not consider the continuity of the tactile stroke.

The main objective of this paper is to develop an effective rendering method for a tactile stroke moving along an arbitrarily shaped trajectory on the human hand, using a sparse 2D factor array. Our work is based on the tactile brush algorithm proposed in [1] and seeks to improve its robustness in creating tactile strokes along arbitrary paths. We propose a strategy to overcome the limitations of the tactile brush algorithm and present experimental results that compare our proposed method to the tactile brush.

## 2 Rendering Moving Tactile Strokes on Sparse 2D Arrays

### 2.1 A Review of the Tactile Brush Algorithm [1]

The tactile brush algorithm has several notable features including the use of tactile illusions to create the sensation of moving tactile strokes. The authors utilized apparent tactile motion and phantom sensation in their algorithm. Apparent tactile motion is an illusory phenomenon such that two closely-placed vibrotactile stimuli are perceived to come from a single factor continuously moving between them [10]. The effect can be created by adjusting the stimulus duration and inter-stimulus signal onset asynchrony (SOA), the time interval between the onsets of subsequent actuations. Results of psychophysics experiments indicated that the following relation was optimal for making successive signals feel like a single moving stroke:

$$SOA = 0.32 \cdot duration + 0.0473 \quad (1)$$

where SOA and duration are in seconds.

The tactile brush algorithm removed the restriction that a tactile stroke trajectory can only move along the line segments between physical factors. It used the phantom tactile sensation that lets a user feel an illusory vibratory factor between two simultaneously activated physical factors. A control strategy for the location and intensity of the stimuli was found based on an energy model. When the desired intensity of virtual factor is  $A_v$  and the distance between the virtual factor and the  $i$ -th physical factor is  $d_i$ , the intensity of each physical factor  $A_i$  is controlled by the following equation:

$$A_1 = \sqrt{\frac{d_2}{d_1 + d_2}} A_v, A_2 = \sqrt{\frac{d_1}{d_1 + d_2}} A_v \quad (2)$$

The equation assumes that the energy summation model in the Pacinian channel [11] and that the energy moment due to each physical factor is constant as follows:

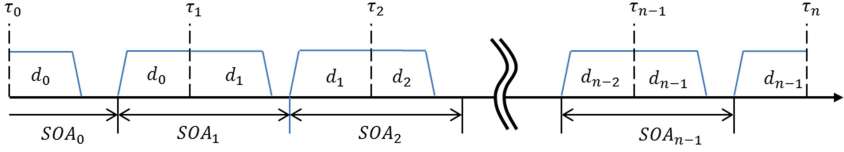

**Fig. 1.** Timing diagram of the tactile brush algorithm for  $n + 1$  factors

$$A_v^2 = A_1^2 + A_2^2 \quad (3)$$

$$d_1 \cdot A_1^2 = d_2 \cdot A_2^2 = \text{const}. \quad (4)$$

It should be noted that the tactile brush algorithm assumes that the intensities of two successively-activated factors can be independently modulated.

The tactile brush algorithm renders moving tactile strokes by controlling the SOA and the signal duration of physical/phantom factors. Once the trajectory and velocity of the tactile stroke are determined, the time  $\tau_i$  at which the intensity of the  $i$ -th factor is at the maximum can be decided ( $i = 0, \dots, n$ ). The timing diagram of the signals (Fig. 1) shows that  $SOA_0 + d_0 = \tau_1$ . Then with Eq. (1),  $SOA_0$  and  $d_0$  are decided. For  $i > 0$ , the  $i$ -th factor is driven after  $SOA_{i-1}$  and is active for  $d_{i-1} + d_i$  seconds. Assuming that the  $i$ -th factor is at its maximum intensity  $d_{i-1}$  seconds after the activation, then Eq. (1) can be extended to obtain the following relations at the  $i$ -th step:

$$SOA_i = 0.32(d_{i-1} + d_i) + 0.0473 \quad (5)$$

$$\sum_{j=0}^i SOA_j + d_i = \tau_{i+1} \quad (6)$$

Combining the above two equations results in the following equation for  $d_i$ :

$$d_i = 0.76\tau_{i+1} - 0.24d_{i-1} - 0.76 \sum_{j=0}^{i-1} SOA_j - 0.036 \quad (7)$$

and  $SOA_i$  is derived from Eq. (5).

The tactile brush algorithm restricts the tactile stroke path to move on line-segment paths whose endpoints are on the gridlines defined by physical factors. Then, to create a tactile stroke along a curved path, a denser array is required as in Fig. 2(a). Another drawback of the algorithm concerns the robustness of the algorithm when the two consecutive factors share a common physical factor and the two factors are supposed to be active simultaneously. Figure 2(b) shows an example where the trajectory of a tactile stroke passes over three phantom factors. As shown in the timing diagram in the rightmost column, the phantom factors  $P_A$  and  $P_B$  can be active at the same time while sharing a common physical factor  $P_2$ . The same problem exists for  $P_B$  and  $P_C$ . This contradicts the assumption that the phantom factors can be independently controlled and requires additional handling of the intensity of the overlapping physical factor. We propose a new method in the next subsection to overcome the two limitations of the tactile brush algorithm.

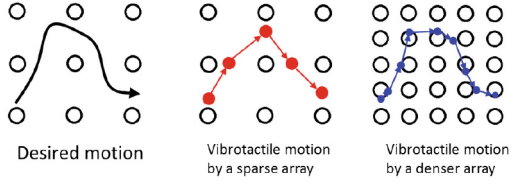

(a) Linear motion constraint

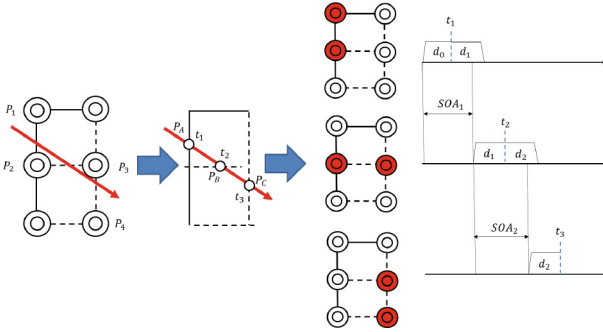

(b) Overlapping physical factor

**Fig. 2.** Drawbacks of the tactile brush algorithm

**2.2 A New Algorithm for Non-linear Arbitrary 2D Trajectories**

In this section, we address the two major limitations of the tactile brush algorithm: (i) linear path constraint and (ii) overlapping physical factors for consecutive factors. To avoid the path constraint, we extend the scheme of phantom factor from two factors to three factors forming a triangle out of a rectangular grid as shown in Fig. 3. Then, Eqs. (2) and (3) for the energy summation and the constant energy moment assumptions are extended to the following relations:

$$A_v^2 = \sum_{i=1}^3 A_i^2 \tag{8}$$

$$d_1 \cdot A_1^2 = d_2 \cdot A_2^2 = d_3 \cdot A_3^2 = const. \tag{9}$$

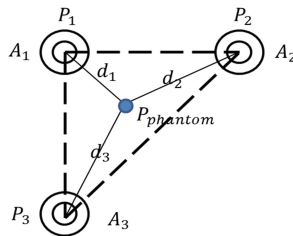

**Fig. 3.** Phantom factor at an arbitrary position inside a triangle formed by three factors

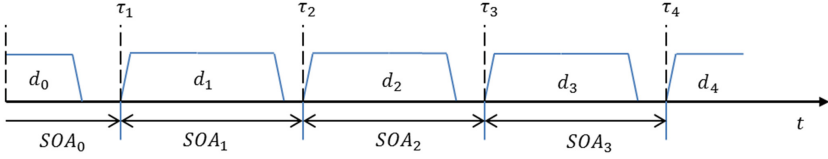

**Fig. 4.** Timing diagram of the new algorithm that avoids overlapping consecutive factors

Next, given a phantom factor  $P_{phantom}$  located at an arbitrary position inside of the triangle, the intensity of each factor is

$$A_i = \sqrt{\frac{1/d_i}{\sum_{j=1}^3 1/d_j}} A_v \quad (10)$$

where  $d_i$  is the distance between  $P_{phantom}$  and the physical factor  $P_i$  and  $A_v$  is the target intensity.

The problem of overlapping physical factor can be avoided by setting the duration of each factor to be shorter than SOA. Combining it with Eq. (1), we have:

$$SOA = 0.32 \cdot duration + 0.0473 \geq duration \quad (11)$$

which results in the constraint that  $duration \leq 0.07$  s. Two consecutive factors will never overlap in time and the problem of overlapping factor is avoided (Fig. 4).

Our new algorithm is robust and simple to implement, as follows. Given a desired trajectory as a time constant, points on the path are sampled at a rate less than or equal to 0.07 s following the constraint of Eq. (11). The sampling rate is assumed as the SOA of each factor and the duration is calculated by Eq. (1). At each point, the three closest physical factors around the point are selected and the intensity of each factor is decided by Eq. (10). If the point is aligned on a line segment, the intensity of each physical factor is decided by Eq. (2). The new algorithm improves upon the tactile brush algorithm in terms of the degrees of freedom in paths and the robustness in handling subsequent factors.

### 3 Comparison of Moving Tactile Strokes Generated by the Tactile Brush and the New Algorithm: An Experiment

#### 3.1 Experimental Method

The experimental apparatus consisted of a 3-by-3 sparse array of piezoelectric actuators (a 9-mm ceramic disk mounted concentrically on a 12-mm metal disk; Murata, Inc., Kyoto, Japan). The top of the apparatus has a curvature of 14 cm to ensure that the surface adheres well to a participant's palm during the experiment (Fig. 5). The piezos are arranged with a center-to-center spacing of 20 mm. To create a vibrotactile stimulus, a source signal is generated from an analog output from a multifunction I/O card

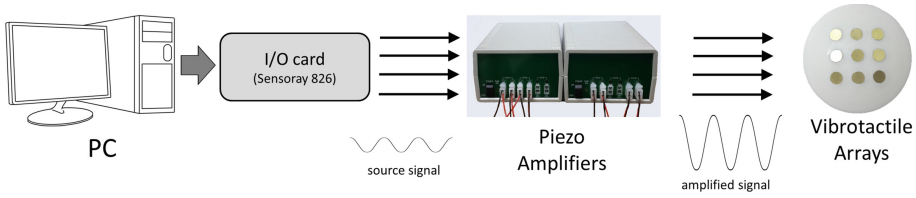

Fig. 5. Block diagram of the experimental setup

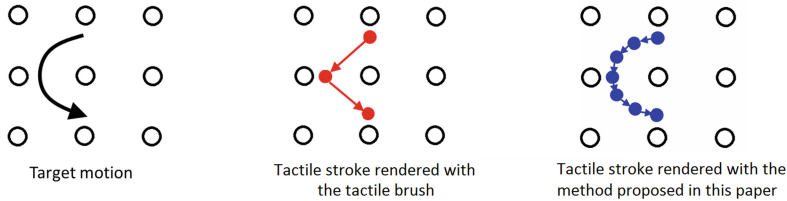

Fig. 6. Target motion and tactile strokes rendered by the tactile brush and our new method

(Model 826, Sensoray Co., Inc, OR, USA) and is sent to a custom-built piezo amplifier (Fig. 5). The source sinusoidal signals had a frequency of 250 Hz around which human sensitivity to vibratory signal is the highest [12]. An amplitude of 7 dB SL (sensation level, dB above human detection threshold) was used.

A haptic stimulus for the experiment is rendered with either the tactile brush algorithm or the new method proposed in Sect. 2 for a target moving at a constant speed. Figure 6 describes an example of comparing the two rendering methods. The tactile brush renders phantom factors aligned on a line segment on a grid, which creates a piecewise linear motion. Our new algorithm samples points on the target trajectory at a period of 0.07 s and renders each point by adjusting factor intensities of the nearest three factors using the relation in Eq. (8).

### 3.2 Procedures

Twelve participants (nine males) aged between 26 and 36 took part in the experiment. None of them had any known problem with the sense of touch by self-report. The experiment protocol was approved by the KIST IRB.

Each participant conducted four experimental runs. One run tested the perceived similarity between the intended tactile stroke motion and the trajectories rendered by the two algorithms (*similarity test*). Another run tested the perceived uniformity of rendered tactile stroke motions (*uniformity test*). The other two runs asked the participants to rate the similarity of the tactile strokes to the target trajectories (*similarity rating*) and the uniformity of the tactile stroke motion rendered by the two algorithms (*uniformity rating*), both on a 5-point Likert scale. The four target motions shown in Fig. 7 were used in the experiment and the total number of trials for each run was 40.

The participant sat in front of the experiment computer and placed his/her hand over the experimental apparatus. A noise cancelling headphone was worn by the

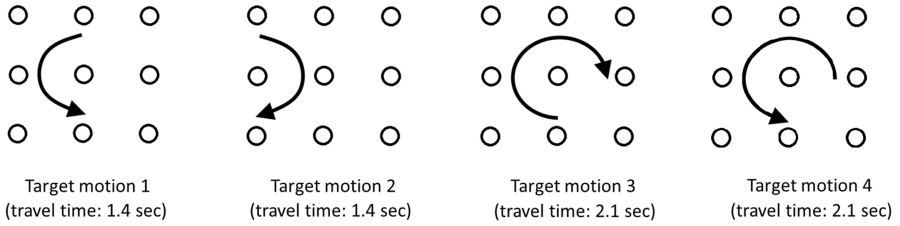
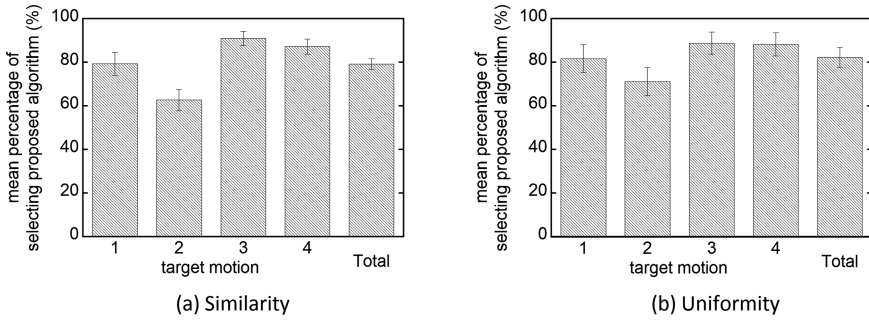

**Fig. 7.** Four target motions used for the experiment

participant and it played white noise when the piezo actuators were driven. The factors were sequentially turned on to check if all of them were functioning normally. If no problem was found, the participant could proceed to the experiment. At each trial, one of the trajectories in Fig. 7 was randomly selected. For the similarity test, an animation showing the target motion was displayed visually on the computer screen. Then, the target motion was rendered with the two algorithms sequentially. The order of the rendering method was randomized for each trial. After feeling the two tactile stimuli, the participant was asked to respond which one moved along a trajectory that was felt more similar to that of the animation. For the uniformity test, no animation was shown visually. The participant felt two tactile strokes and had to decide which of the tactile strokes was perceived to have moved with a more uniform velocity. For the similarity rating test, the animation of target motion was shown at the beginning of the trial and one of the two rendering algorithms was randomly selected. After feeling the tactile stimulus, the participant rated the similarity of the sensation to that of the animation on a 5-point Likert scale. For the uniformity rating test, no animation was shown. The participant felt a tactile stroke rendered with one of the methods and rated the uniformity of the perceived stroke velocity on a 5-point Likert scale. It took approximately 30 min for each participant to complete the experiment, including the breaks between subsequent experimental runs.

## 4 Results

Figure 8 shows the results for the similarity and uniformity tests. The mean percentages of participants' preference for the new rendering method proposed in this paper over the tactile brush algorithm were 79.2 % and 82.3 % for the similarity test and the uniformity test, respectively. When the percentages were compared to 50 % by one-sampled t-tests, significant differences were found for both the similarity test [ $t(11) = 6.84$ ,  $p < 0.001$ ] and the uniformity test [ $t(11) = 5.5$ ,  $p < 0.001$ ]. The mean percentage of preferring the new algorithm was also significantly different from 50 % for all individual target motions. A one-way repeated measure ANOVA for the similarity test with the factor target motion revealed a significant effect [ $F(3,33) = 11.428$ ,  $p < 0.001$ ]. Post-hoc analysis using Tukey's pairwise comparisons indicated that the mean percentage of preferring the new algorithm for target motion 2 is different from those for the other target motions. A one-way repeated measure ANOVA for the uniformity test with the factor target motion also revealed a significant effect [ $F(3,33) = 4.4$ ,  $p = 0.01$ ].



**Fig. 8.** Mean percentage of preferring the new rendering algorithm for (a) the similarity test and (b) the uniformity test. Error bars indicate standard errors.

Tukey’s pairwise comparisons indicated that the mean percentage of preferring the new algorithm for target motion 2 is different from those for target motions 3 and 4, but not target motion 1.

Figure 9 shows the mean ratings for the similarity and uniformity rating tests. The mean ratings for the similarity rating test were 2.65 and 3.89 for the tactile brush and the new algorithm, respectively. For the uniformity rating test, the mean ratings were 2.51 and 3.74 for the tactile brush and the new algorithm, respectively. When pairwise t-test was conducted between the mean ratings of the two rendering methods, significant differences were found for both the similarity ratings [ $t(11) = 13.23, p < 0.001$ ] and the uniformity ratings [ $t(11) = 8.06, p < 0.001$ ]. A two-way ANOVA for the similarity ratings with the factors algorithm and target motion indicated significant main effects of algorithm [ $F(1,11) = 40.66, p < 0.001$ ] and target motion [ $F(3,33) = 9.1, p < 0.001$ ]. We also found a significant interaction of algorithm and target motion [ $F(3,33) = 7.87, p < 0.001$ ]. Tukey’s pairwise comparisons indicated that for the tactile brush algorithm, no significant difference was found for the mean ratings by target motions. When the new algorithm was used, the mean ratings of target motions 3 and 4 did not differ significantly from one another, but were significantly larger than that of target motion 2. The ratings for target motions 1 and 2 did not differ from one another. A two-way

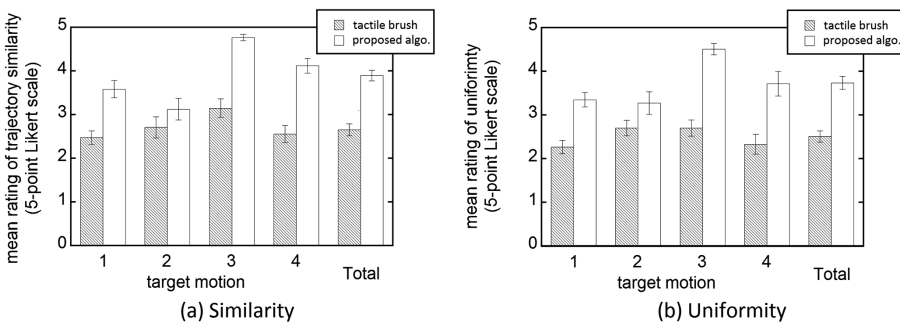

**Fig. 9.** Mean ratings of the tactile brush and the new algorithm for the similarity and uniformity tests. Error bars indicate standard errors.



ANOVA for the uniformity ratings also indicated significant main effects of algorithm [ $F(1,11) = 40.04, p < 0.001$ ] and target motion [ $F(3,33) = 6.51, p = 0.001$ ]. A significant interaction of algorithm and target motion was also found [ $F(3,33) = 3.91, p = 0.02$ ]. Tukey's pairwise comparisons indicated that for the tactile brush algorithm, no significant difference was found for the mean ratings by target motions. When the new algorithm was used, the mean rating of target motions 3 and 4 did not differ from one another, but were significantly larger than that of target motion 2. The ratings for the target motions 1 and 2 did not differ significantly from one another.

The experimental results indicate that our proposed algorithm led the participants to perceive the tactile stroke to move along paths closer to the target trajectories and with more uniform velocities than the tactile brush algorithm. Also, the effect was more significant for target motions 3 and 4 which are longer in travel length and time duration than target motions 1 and 2.

## 5 Discussion

The present study proposed and evaluated a rendering method for tactile strokes on the palm of the hand placed on a sparse 2D array. The algorithm utilized the relation between signal duration and signal onset asynchrony derived from the tactile brush algorithm, to create the sensation of moving tactile strokes. Drawbacks of the tactile brush algorithm in linear motion constraint and robustness were addressed in the new rendering method by applying 3-actuator phantom sensations and adjusting the sampling rate. Our new algorithm was compared to the tactile brush algorithm with a user study. The results indicate that the participants perceived the moving tactile stroke rendered with the new method to be significantly better in terms of trajectory shape and velocity uniformity.

The algorithm proposed in the present study is expected to be useful for applications using desktop interfaces and handheld/wearable devices. Future work will include more detailed examination of the effect of factor parameters (e.g., factor size and signal frequency) on the perception of tactile strokes. In addition, other factors that can possibly affect human haptic perception of tactile strokes, for example the location of tactile arrays on the body, will be studied to further improve the effectiveness and robustness of our proposed rendering method.

**Acknowledgement.** This work was supported by the Global Frontier R&D program on < Human-centered Interaction for Coexistence > of the National Research Foundation of Korea funded by the Korean Government (MSIP) (2013M3A6A3078404) and the KIST Institutional Program (2E26460).

## References

1. Israr, A., Poupyrev, I.: Tactile brush: drawing on skin with a tactile grid display. In: Proceedings of the SIGCHI Conference on Human Factors in Computing Systems, pp. 2019–2028 (2011)

2. Cholewiak, R.W., Collins, A.A.: The generation of vibrotactile patterns on a linear array: influences of body site, time, and presentation mode. *Percept. Psychophys.* **62**(2), 1220–1235 (2000)
3. Borst, C.W., Cavanaugh, C.D.: Touchpad-driven haptic communication using a palm-sized vibrotactile array with an open-hardware controller design. In: *EuroHaptics Conference*, Munich, pp. 344–347 (2004)
4. Tan, H.Z., Gray, R., Young, J.J., Traylor, R.: A haptic back display for attentional and directional cueing. *Haptics-e: Electron. J. Haptics Res.* **3**(1), 20 (2003)
5. Yatani, K., Truong, K.N.: SemFeel: a user interface with semantic tactile feedback for mobile touch-screen devices. In: *Proceedings of the 22nd Annual ACM Symposium on User Interface Software and Technology*, pp. 111–120 (2009)
6. Tan, H.Z., Lim, A., Traylor, R.: A psychophysical study of sensory saltation with an open response paradigm. In: *Proceedings of the Ninth (9th) International Symposium on Haptic Interfaces for Virtual Environment and Teleoperator Systems*, American Society of Mechanical Engineers Dynamic Systems and Control Division, pp. 1109–1115 (2000)
7. Alles, D.: Information transmission by phantom sensations. *IEEE Trans. Man-Mach. Syst.* **1**(11), 85–91 (1970)
8. Seo, J., Choi, S.: Initial study for creating linearly moving vibrotactile sensation on mobile device. In: *2010 IEEE Haptics Symposium*, pp. 67–70 (2010)
9. Schneider, O.S., Israr, A., MacLean, K.E.: Tactile animation by direct manipulation of grid displays. In: *Proceedings of the 28th Annual ACM Symposium on User Interface Software & Technology*, pp. 21–30 (2015)
10. Sherrick, C.E., Rogers, R.: Apparent haptic movement. *Percept. Psychophys.* **1**(3), 175–180 (1966)
11. Makous, J.C., Friedman, R.M., Vierck, C.J.: A critical band filter in touch. *J. Neurosci.* **15**(4), 2808–2818 (1995)
12. Johansson, R.S., Flanagan, J.R.: Coding and use of tactile signals from the fingertips in object manipulation tasks. *Nat. Rev. Neurosci.* **10**(5), 345–359 (2009)